



SP-35XMV

DC Ammeter for Battery
Powered Systems
3 1/2 Digit 0.48" LCD
in a Slim Bezel Case

Compact DC Ammeter with Screw Terminal and Edge Connector Inputs.

General Features

The SP-35XMV is a compact 3 1/2 digit, 4 wire DC millivolt meter. By connecting across a 50 mV/100 mV current shunt the meter can be user calibrated to read DC current. An internal header selects "HI side" or "LO side" shunt configuration. A wide range power supply allows the meter to be connected to most common battery powered systems.

Typical Application Connections

HI Side Shunt Configuration. Negative Ground.

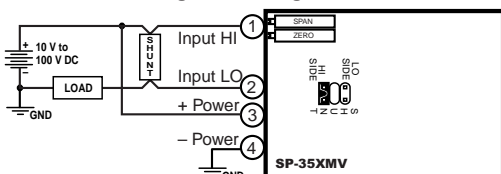

LO Side Shunt Configuration. Negative Ground.

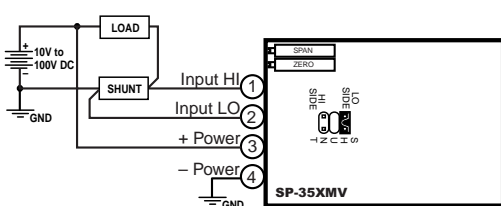

HI Side Shunt Configuration. Positive Ground.

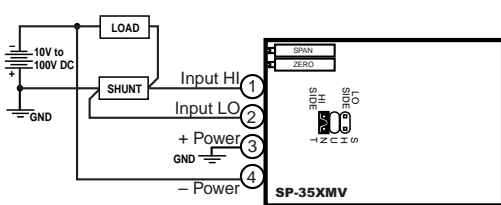

LO Side Shunt Configuration. Positive Ground.

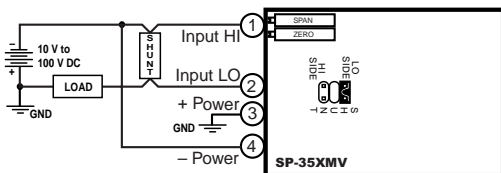

Compatibility

The SP-Series is shipped in a standard Slim Bezel case. The Slim Bezel case is compatible with the CM, SM, PM, & TM Series of meters. The SP-Series can be ordered in End Mount cases for twin mounting or combinations of multiple center mount cases and two end mount cases for stack mounting.

SLIM



BEZEL

Specifications

Input Configuration:Differential. Header selectable for "HI side" or "LO side" shunt configurations.

Input Impedance:500KΩ

Full Scale Ranges:± 1999A or ±199.9mV

A/D Converter:12 Bit Dual Slope A/D Converter

Accuracy:±(0.05% of reading + 2 digits)

Temperature Coefficient: 100ppm/°C Typical

Warm Up Time:10 seconds to specified accuracy.

Conversion Rate:3 reading per second

Display:0.48" 3 1/2 Digit Liquid Crystal Display (LCD)

Decimal Selection:User Selectable

Positive Overrange :1 (MSD) is displayed with all other digits blank

Negative Overrange :1 (MSD) and - sign are displayed with all other digits blank

Power Supply (std):10 to 100V DC or 18 to 36V AC

Operating Temperature: ..0°C to 60°C

Storage Temperature:0°C to 70°C

Relative Humidity:95% (non condensing)

Case Dimensions:Bezel 2.76" x 1.17" (69.75 x 29.7mm)
Depth behind Bezel 3.32"(84mm)
plus 0.68" (17.27mm) for connector

Weight:143 gms (5 oz) when packed

SP-Series, low cost meters for voltage and current measurement

SP-35X.....3.5 digit LCD, Signal Powered by DC voltage
SP-35XMV.....3.5 digit LCD DCMV Input, 10-100VDC or 18-36VAC Pwr

SP-35XRMS3.5 digit LCD, VAC RMS Signal Pwr, 15.0-199.9VAC/DC

Functional Diagram

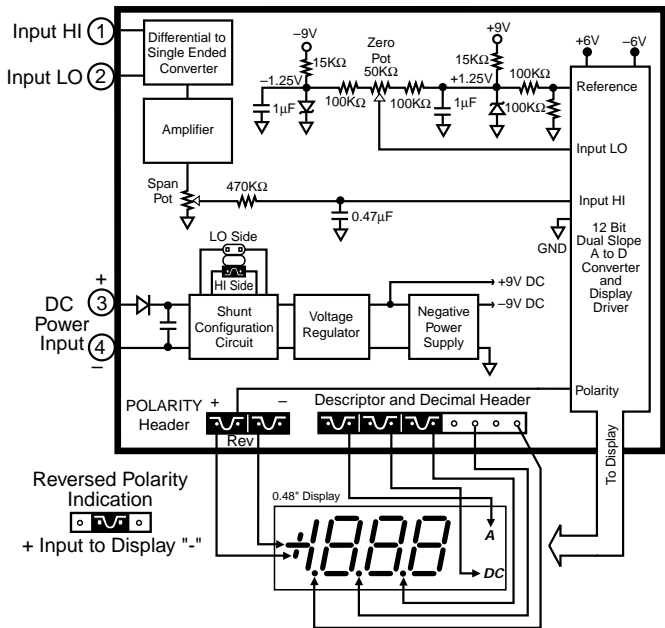

Connector Pinouts

The Texmate SP-35X MV are connectable using the TB-KIT screw terminal blocks provided with the meter. For greatest convenience, order a Texmate Push-On screw terminal connector. Alternatively, a pcb edge connector can be used. (see connector options on page 3)

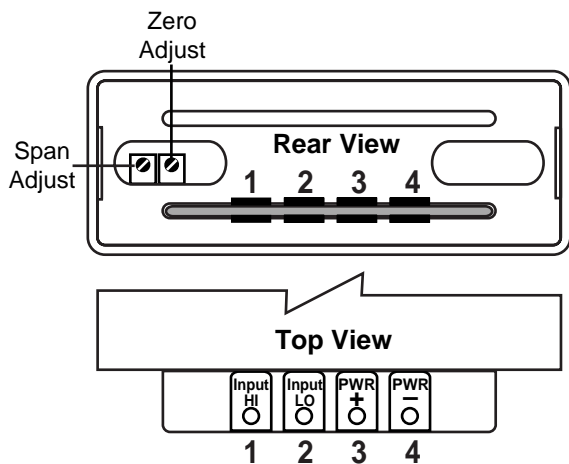

WARNING: AC and DC input signals and power supply voltages can be hazardous. Do Not connect live wires to screw terminal plugs, and do not insert, remove or handle screw terminal plugs with live wires connected.

Pin 1 - Input HI: For DC current measurement with an external shunt, the more positive end of the shunt is connected to this pin. 50mV/100mV shunts may be used. For maximum accuracy 4 wire Kelvin connected shunts are recommended. An internal header configures the meter for HI Side or LO Side Shunt circuits.

Pin 2 - Input LO: For DC current measurement with an external shunt, the less positive end of the shunt is connected to this pin. 50mV/100mV shunts may be used. For maximum accuracy 4 wire Kelvin connected shunts are recommended. An internal header configures the meter for HI Side or LO Side Shunt circuits.

Pin 3 - Power (+) Positive: The positive terminal of the battery is connected to this pin. The battery voltage can range from 10 V to 100 VDC. For positive ground systems this pin is directly connected to ground. If the power connections to the meter are reversed the display will turn off.

Pin 4 - Power (-) Negative: The negative terminal of the battery is connected to this pin. For negative ground systems this pin is directly connected to ground. If the power connections to the meter are reversed the display will turn off.

Component Layout

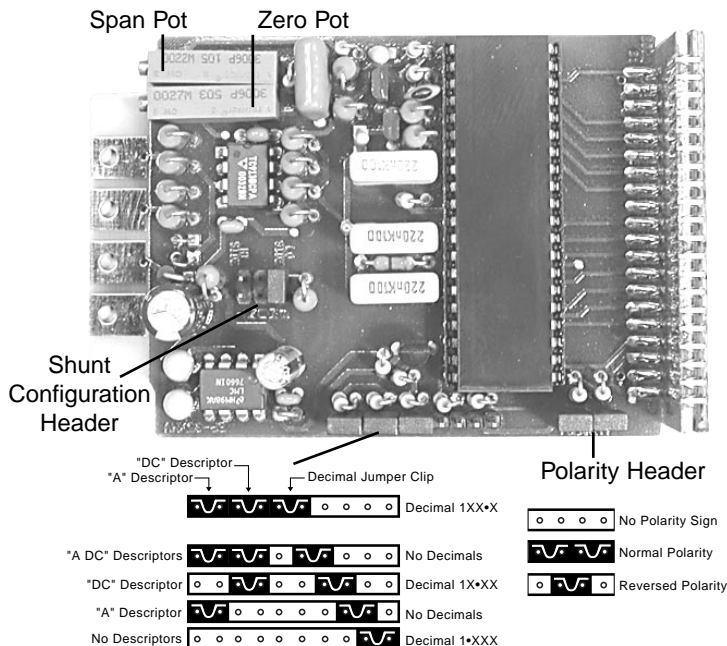

Signal Conditioning Components

SHUNT CONFIGURATION HEADER

Allows the meter to be configured for HI side or LO side shunts.

LO SIDE HI SIDE If one end of the shunt is connected to the negative terminal of the battery, the configuration is known as a LO side shunt. This is true for both positive ground and negative ground circuits. For this configuration, insert the jumper clip in the LO side position.

LO SIDE HI SIDE If one end of the shunt is connected to the positive terminal of the battery, the configuration is known as a HI side shunt. This is true for both positive ground and negative ground circuits. For this configuration, insert the jumper clip in the HI side position.

SPAN SPAN Potentiometer (Pot)

To the Right Front Turn Clockwise to Increase Reading The 15 turn SPAN pot is always on the left side (as viewed from the back of the meter). Typical adjustment is 100% of the input signal range.

ZERO ZERO Potentiometer (Pot)

To the Left Front Turn Clockwise to Increase Reading The ZERO pot is always to the right of the SPAN pot (as viewed from the back of the meter). Typically it enables the displayed reading to be offset ± 1000 counts.

Polarity Display Header

This header allows the Polarity indication to be displayed normally, displayed reversed or to be disabled completely.

Calibration Procedure

To Measure Amps with an External Shunt

- 1) Connect up the SP-35X MV meter as per the appropriate connection diagram. Be sure to select the correct LO side or HI side position on the internal Shunt Configuration Header.
- 2) With zero current flowing through the Shunt, adjust the Zero Pot so that the display reads 000.
- 3) Pass a known current through the shunt and adjust the

SPAN pot for the desired reading.

- 4) If decimals or descriptors are required, position jumper clips on the Decimal and Descriptors Header.
- 5) The SP-35XMV is now calibrated and ready to use.

To Measure Millivolts

- 1) Select the LO side position on the internal Shunt Configuration Header and the 1XX.X Decimal point.
- 2) With zero input, adjust the Zero Pot so the display reads 000.
- 3) With a known input in the $\pm 200\text{mV}$ range adjust the SPAN pot for the desired reading.
- 4) The SP-35XMV is now calibrated and ready to use as a $\pm 200\text{mV}$ DC Millivolt meter.

Measuring Volts and Amps in a DC Powered System

The SP-35XMV, when used with its companion meter SP-35X, is an elegant solution to the problem of measuring and displaying voltage and current in DC powered systems. To simplify the installation when used together, specify the stackable case option to mount both meters in a single cutout. Our customers have used this combination of meters in DC power supplies, DC generators and in battery back-up systems.

Features such as the low current consumption, wide supply range, large 0.8" display, built in V DC and A DC descriptors, simple connections and user friendly re-scaling to match shunts from 50 mV to 100 mV have made the SP-35XMV and SP-35X the choice of OEMs worldwide.

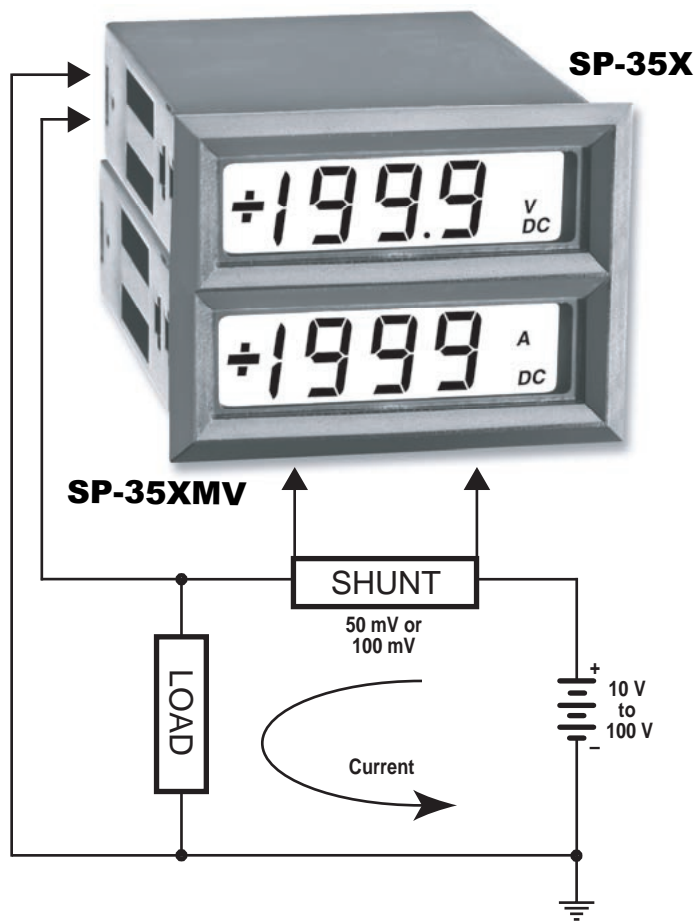

TB-Kit Screw Connectors

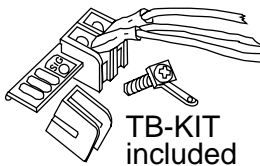

Texmate's individual screw terminal blocks offer a convenient alternative to edge connectors for many applications, allowing complete installation, configuration and calibration without the need for soldering.

Slide each terminal block over the PCB until the hole aligns. Insert the retaining screw to secure. Each kit includes: 3 plastic blocks with metal contacts, 4 screws with spade connectors, 1 metal contact and 3 quick disconnects.

Push-On Screw Terminals

They provide the greatest convenience and ease of use. Texmate's exclusive optional Push-On Connectors combine an edge card connector and a 10 position screw terminal block. Push-On Connectors are ordered preconfigured for each specific power supply voltage and each optional power supply available for the SP-Series.



Part Number: CN-PUSH/SP

Optional PCB Edge Connector

PCB Edge Connector. A standard 20-pin edge connector (two rows of 10 pins on 0.156" centers) may also be used to connect the SP-35XMV meter. Order part no. CN-L10.



Stack Option

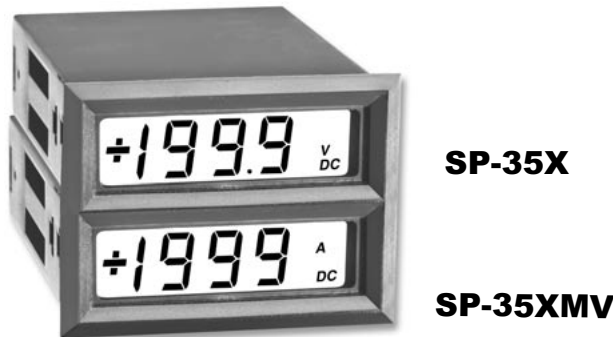

The SP-35XMV measures DC current. A companion meter, the SP-35X measures DC voltages up to 199.9V. The two meters combined in stacking cases are ideal for voltage and current measurements in battery powered systems

SP Case Dimensions and Panel Cutouts

The Slim Bezel Case is supplied as standard. If specified at time of ordering, any combination of Twin Mounting and Multiple Array Cases may be substituted at no additional cost. Extra cases may be ordered separately.

STANDARD SLIM BEZEL CASE

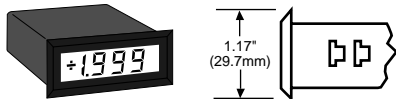

SLIM BEZEL CASE

Standard Black ABS case with matte finish bezel for single unit mounting.

Part No. **SL-CASERED** for LED's
SL-CASECLR for LCD's

OPTIONAL TWIN MOUNTING OR MULTIPLE ARRAY CASES

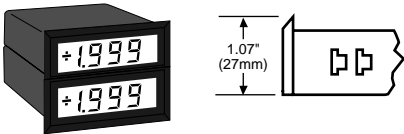

END MOUNT CASE

Same styling as Slim Bezel case but with bottom edge of bezel removed. Two End Mount cases can be twin mounted in a single cutout.

Part No. **EM-CASERED** for LED's
EM-CASECLR for LCD's

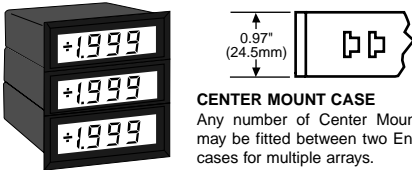

CENTER MOUNT CASE

Any number of Center Mount cases may be fitted between two End Mount cases for multiple arrays.

Part No. **CM-CASERED** for LED's
CM-CASECLR for LCD's

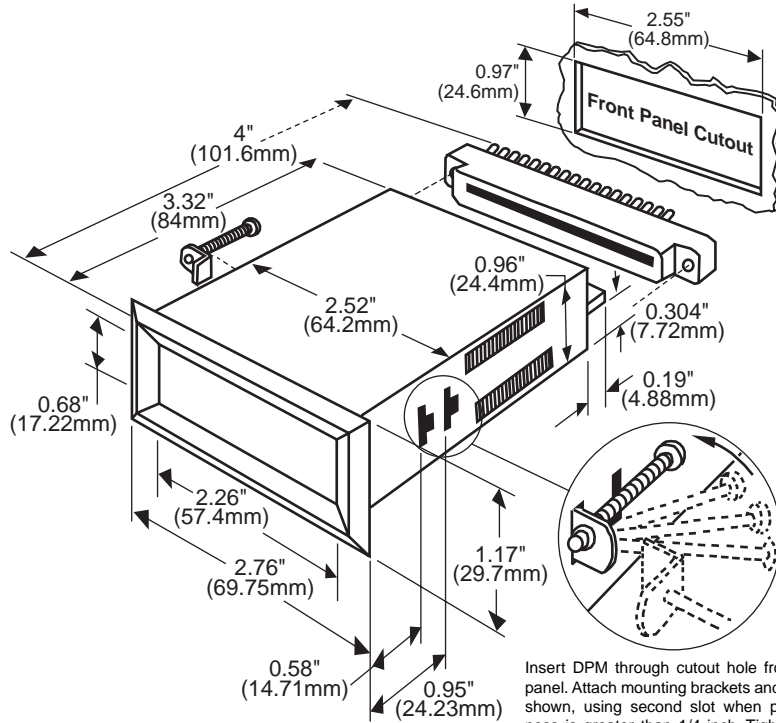

Insert DPM through cutout hole from front of panel. Attach mounting brackets and screws as shown, using second slot when panel thickness is greater than 1/4 inch. Tighten screws against rear of panel.

Ordering Information

Standard Options for this Model Number

Part Number	Description
► BASIC MODEL NUMBER	
SP-35XMV	3.5 digit LCD DCMV Input, 10-100VDC or 18-36VAC Pwr

Special Options and Accessories

Part Number	Description
► SPECIAL OPTIONS (Specify Inputs & Req. Reading)	
CB-FS35	Non-Std Scale Changes, 3.5 Digit Meters
► ACCESSORIES	
CN-L10	Edge Connector with Solder eyelet, 10 Pin Dual
CN-PUSH/SP	Push-on Screw Terminal Block Conn
TB-KIT	Replacement Terminal Block Connector Kit (3)
SL.CASECLR	Slim Bezel Case LCD Std case w/mtg hardware
CM.CASECLR	Slim Bezel Center Case LCD w/mtg hardware
EM.CASECLR	Slim Bezel End Case LCD w/mtg hardware

Prices subject to change without notice.

WARRANTY

Texmate warrants that its products are free from defects in material and workmanship under normal use and service for a period of one year from date of shipment. Texmate's obligations under this warranty are limited to replacement or repair, at its option, at its factory, of any of the products which shall, within the applicable period after shipment, be returned to Texmate's facility, transportation charges pre-paid, and which are, after examination, disclosed to the satisfaction of Texmate to be thus defective. The warranty shall not apply to any equipment which shall have been repaired or altered, except by Texmate, or which shall have been subjected to misuse, negligence, or accident. In no case shall Texmate's liability exceed the original purchase price. The aforementioned provisions do not extend the original warranty period of any product which has been either repaired or replaced by Texmate.

USER'S RESPONSIBILITY

We are pleased to offer suggestions on the use of our various products either by way of printed matter or through direct contact with our sales/application engineering staff. However, since we have no control over the use of our products once they are shipped, NO WARRANTY WHETHER OF MERCHANTABILITY, FITNESS FOR PURPOSE, OR OTHERWISE is made beyond the repair, replacement, or refund of purchase price at the sole discretion of Texmate. Users shall determine the suitability of the product for the intended application before using, and the users assume all risk and liability whatsoever in connection therewith, regardless of any of our suggestions or statements as to application or construction. In no event shall Texmate's liability, in law or otherwise, be in excess of the purchase price of the product.

Texmate cannot assume responsibility for any circuitry described. No circuit patent or software licenses are implied. Texmate reserves the right to change circuitry, operating software, specifications, and prices without notice at any time.

TEXMATE INC

995 Park Center Drive • Vista, CA 92081-8397

Tel: 1-760-598-9899 • USA 1-800-839-6283 • That's 1-800-TEXMATE

Fax: 1-760-598-9828 • Email: sales@texmate.com • Web: www.texmate.com

Texmate has facilities in Japan, New Zealand, Taiwan, and Thailand. We also have authorized distributors throughout the USA and in 28 other countries.

For product details visit www.texmate.com

Local Distributor Address